

# VALLHORN

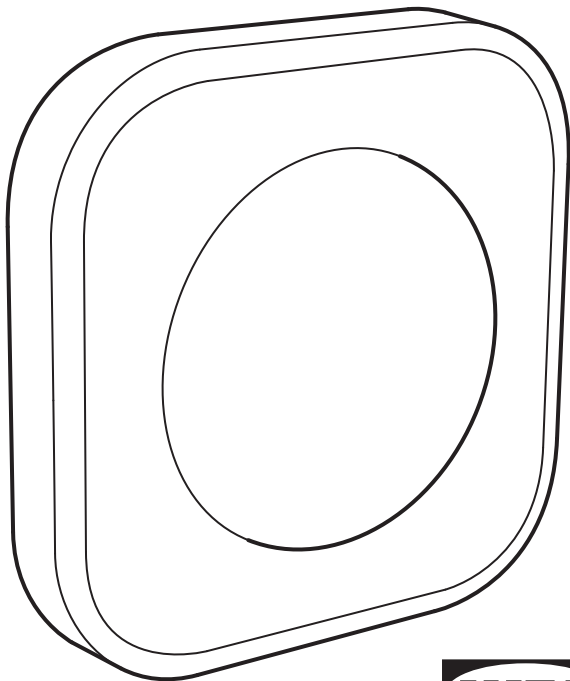

Design and Quality  
IKEA of Sweden



### **English**

Different materials require different types of fittings. Always choose screws and plugs that are specially suited to the material.

### **Deutsch**

Verschiedene Materialien erfordern verschiedene Befestigungsbeschläge. Immer Schrauben und Dübel auswählen, die für das entsprechende Material geeignet sind.

### **Français**

Le choix des vis dépend du matériau dans lequel elles doivent être fixées. Utiliser des vis et chevilles adaptées au matériau du support.

### **Nederlands**

Verschillende materialen vereisen verschillende soorten beslag. Zorg dat de schroeven of pluggen die je kiest bestemd zijn voor het materiaal waar ze in vastgezet moeten worden.

### **Dansk**

Forskellige materialer kræver forskellige typer skruer og rawplugs. Vælg altid skruer og rawplugs, som egner sig til det relevante materiale.

### **Íslenska**

Nota þarf mismunandi festingar í mismunandi veggj. Veljið alltaf skrúfur og tappa sem henta efninu í veggnum.

### **Norsk**

Ulike materialer krever forskjellige typer skruer og beslag. Tenk på at skruene eller pluggene du velger skal være tilpasset materialet de skal festes i.

### **Suomi**

Erilaisiin materiaaleihin tarvitaan erilaiset kiinnikkeet. Valitse kotisi materiaaleihin sopivat ruuvit ja tulpat.

### **Svenska**

Olika material kräver olika typer av beslag. Tänk på att skruvarna eller pluggarna du väljer ska vara avsedda för materialet de ska fästa i.

### **Česky**

Různé druhy materiálů vyžadují různé druhy kování. Vždy použijte šrouby a zásuvky, které jsou vhodné pro daný typ materiálu.



### **Español**

Diferentes materiales requieren diferentes clases de herrajes. Recuerda que los tornillos y tacos que elijas se deben adaptar al material en el que irán sujetos.

### **Italiano**

Materiali diversi richiedono tipi diversi di accessori di fissaggio. Scegli viti e tasselli adatti al materiale a cui vanno fissati.

### **Magyar**

Különböző anyagok, különböző típusú szerelési anyagokat igényelnek. Mindig válassz olyan csavarokat és tipliket, melyek a leginkább megfelelnek a számodra.

### **Polski**

Różne materiały (podłoża) wymagają różnych typów mocowań. Używaj zawsze wkrętów i zatyczek odpowiednich do danego rodzaju materiału (podłoża).

### **Eesti**

Erinevate materjalide puhul kasutatakse erinevaid kinnitusvahendeid. Valige kruvid ja kinnitused, mis sobivad selle pinna materjaliga, kuhu lambi paigaldate.

### **Latviešu**

Stiprinājumi jāizvēlas atkarībā no materiāla. Vienmēr izvēlieties skrūves un dībeļus, kas ir piemēroti konkrētajam materiālam.

### **Lietuvių**

Tvirtinimo elementai pasirenkami pagal medžiagas. Pasirinkite varžtus ir kištukus tinkamus būtent tai medžiagai.

### **Portugues**

Os diferentes tipos de materiais requerem diferentes tipos de fixações. Escolha sempre parafusos e buchas especialmente apropriados para cada material.

### **Româna**

Materialele variate necesită diferite tipuri de accesorii. Alege întotdeauna șuruburi și ștecăre adecvate materialului respectiv.

### **Slovensky**

Rôzne materiály si vyžadujú rozličné typy montážneho kovania. Vždy vyberajte skrutky a zásuvky vhodné k danému materiálu.



### **Български**

Различните материали изискват различни видове фитинги. Винаги подбирайте винтове и болтове, подходящи за материала.

### **Hrvatski**

Različiti materijali zahtijevaju različite vrste okova. Uvijek odaberite vijke i tiple koji točno odgovaraju materijalu.

### **Ελληνικά**

Τα διαφορετικά εξαρτήματα απαιτούν και διαφορετικούς τύπους εξαρτημάτων. Επιλέγετε πάντοτε βίδες και βύσματα, τα οποία να είναι κατάλληλα για το αντίστοιχο υλικό.

### **Русский**

Разные материалы требуют различных типов креплений. Выбирайте шурупы и пробки в соответствии с материалом.

### **Українська**

Для різних матеріалів потрібні різні кріплення. Завжди підбирайте шурупи та гарнітуру залежно від матеріалу.

### **Srpski**

Različite vrste materijala zahtevaju različite spone. Uvek biraj tiplove i zavrtnje koji odgovaraju materijalu.

### **Slovenščina**

Različni materiali zahtevajo različne pritrdilne elemente. Vedno uporabi vijake in zidne vložke, ki so primerni za določen material.

### **Türkçe**

Farklı materyaller farklı türde bağlantı parçaları gerektirir. Her zaman materyale uygun vida ve prizleri tercih edin.

### **中文**

不同的安装面材质须采用不同的固定安装螺钉。务必选择适用的安装螺钉和螺栓。



### 繁體中文

不同材質的牆壁需使用不同種類の上牆配件，請選用適合牆壁材質的螺絲和配件。

### 한국어

고정할 곳의 소재에 따라 다른 종류의 고정장치를 사용해야 합니다. 반드시 소재에 적합한 나사와 칼브력을 사용하세요.

### 日本語

壁の材質により使用できるネジの種類が異なります。壁の材質に合ったネジやネジ固定具を使用してください。

### Bahasa Indonesia

Bahan material yang berbeda memerlukan kelengkapan yang berbeda. Selalu memilih sekrup dan baut yang sesuai dengan bahan material pilihan anda.

### Bahasa Malaysia

Bahan yang berlainan memerlukan jenis pelengkap yang berlainan. Sentiasa pilih skru dan palam yang paling sesuai dengan bahan.

### عربي

المواد المختلفة تتطلب أنواع مختلفة من التركيبات، إختيار البراغي والمقابس التي تناسب خاصية المادة.

### ไทย

วัสดุพื้นผนังและเพดานมีหลายแบบแตกต่างกัน จึงจำเป็นต้องใช้สกรูหรืออุปกรณ์ยึดต่างชนิดกัน ควรเลือกใช้สกรูและฟุตชนิดที่เหมาะสมกับ พื้นผิวที่คุณต้องการติดตั้งโคมไฟ

### Tiếng Việt

Các chất liệu bề mặt khác nhau cần các loại phụ kiện lắp ráp khác nhau. Hãy chọn ốc vít và tắc kê phù hợp với chất liệu.

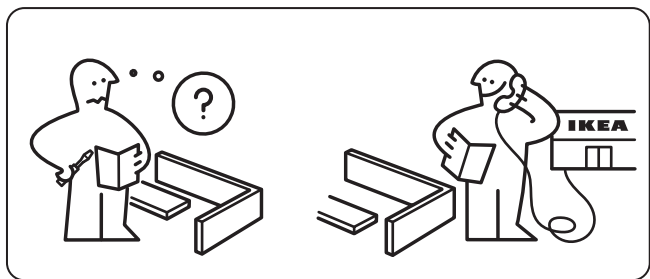
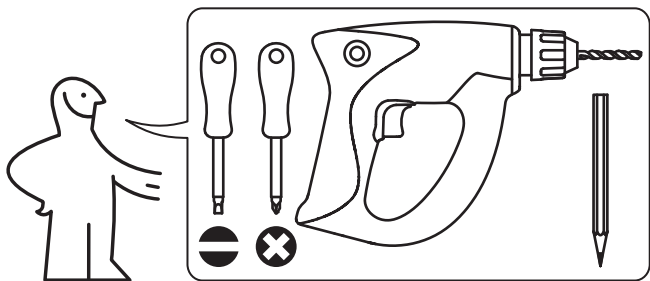

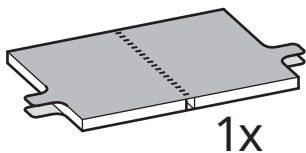

VALLHORN

DIRIGERA



+



=



🔍 IKEA Home smart

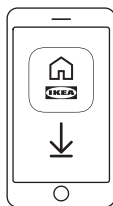

1

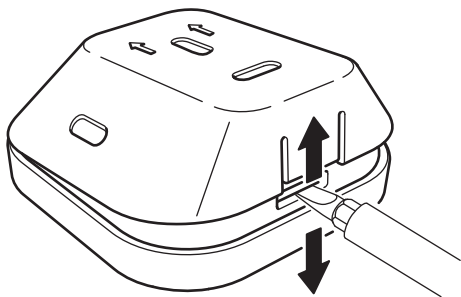
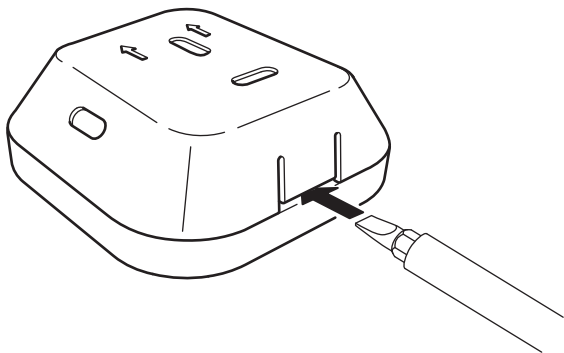



2

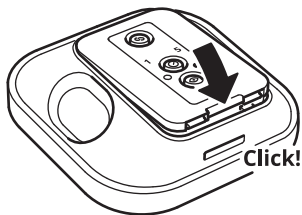
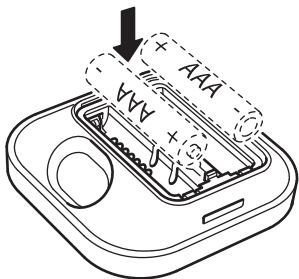
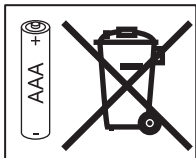
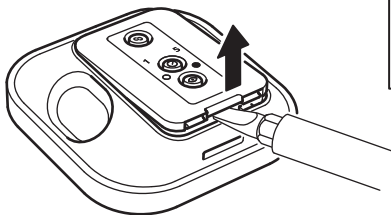



Works with  
IKEA Home smart



1

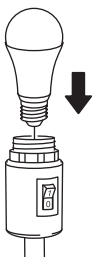

2

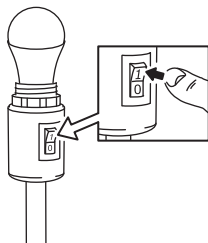

3



max 5 cm  
(max 2")

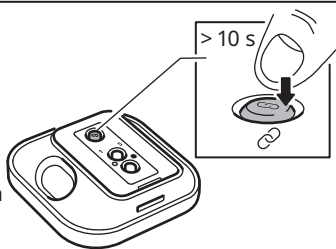

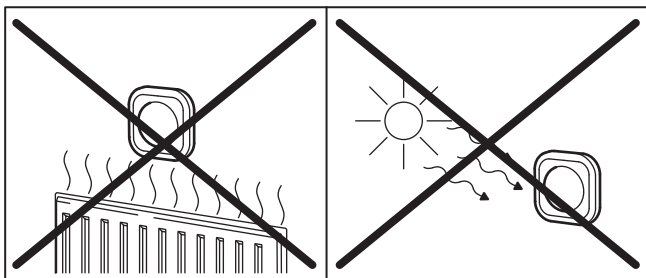
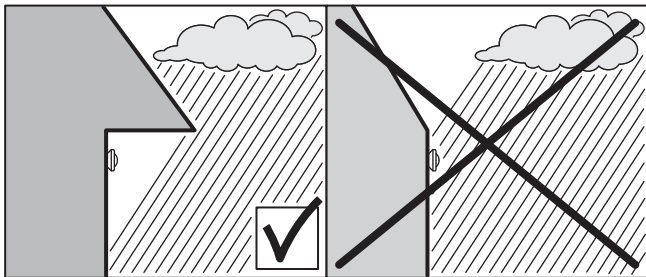
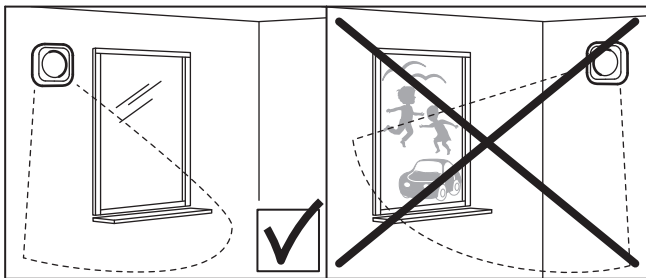

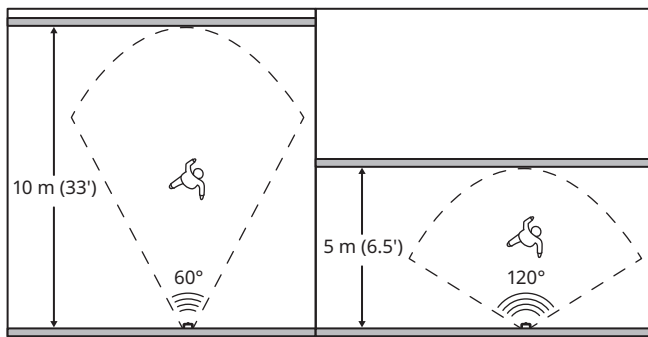

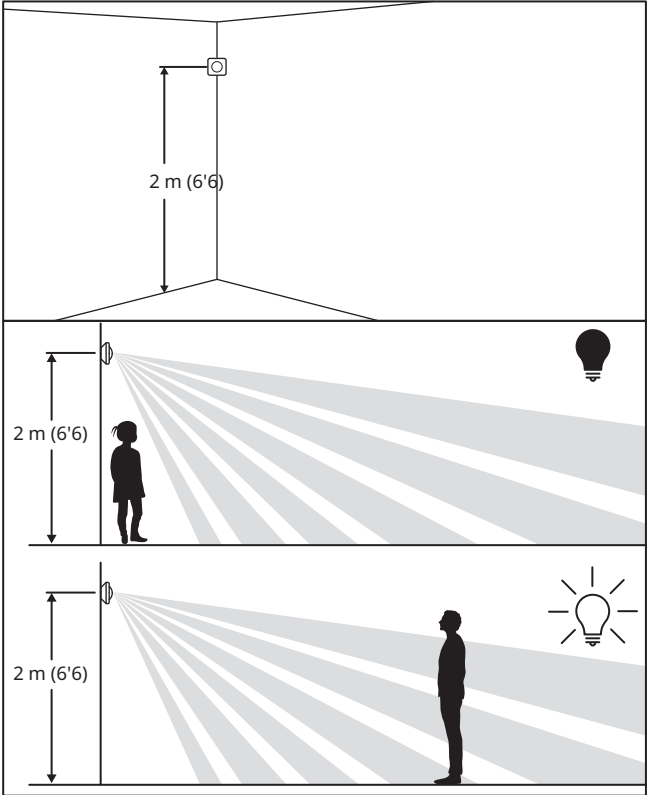

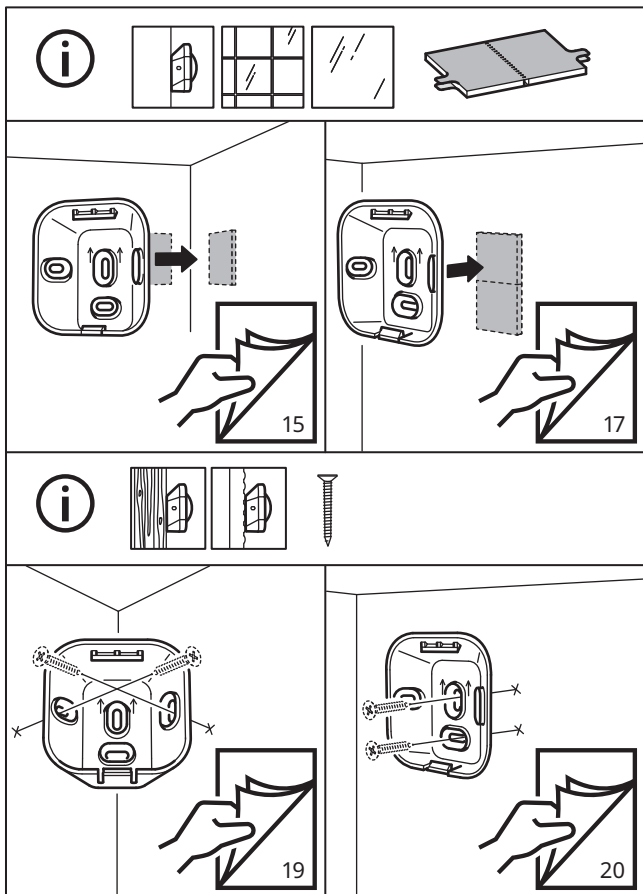

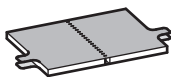
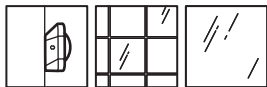

**1**

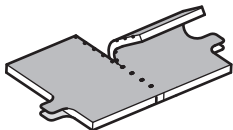

**2**

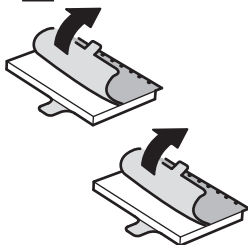

**3**

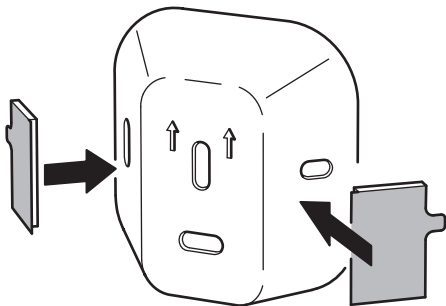

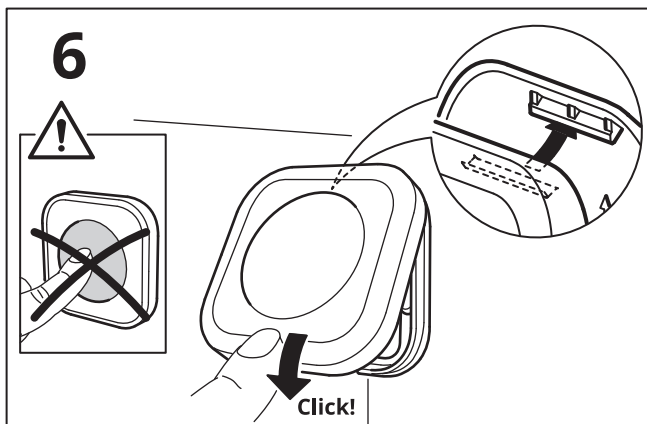
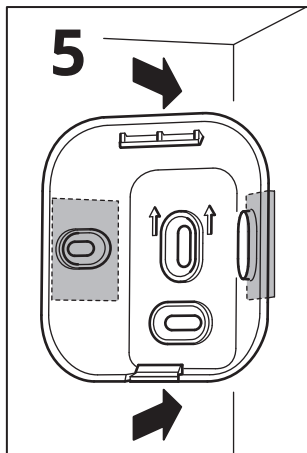
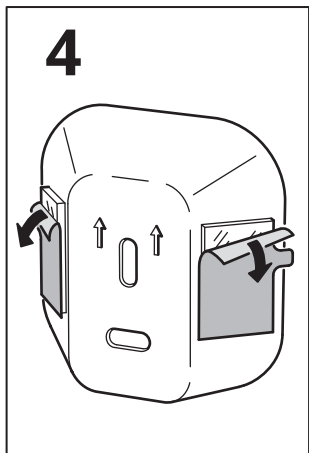



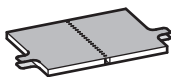
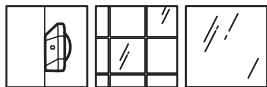

**1**

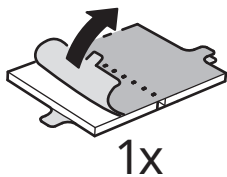

**2**

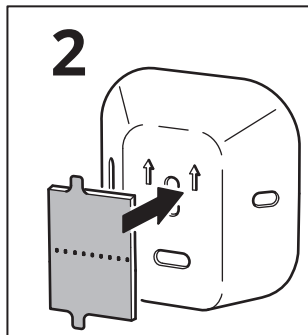

**3**

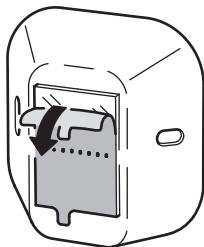

4

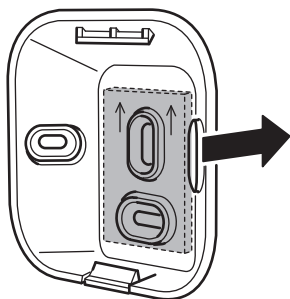

5

